

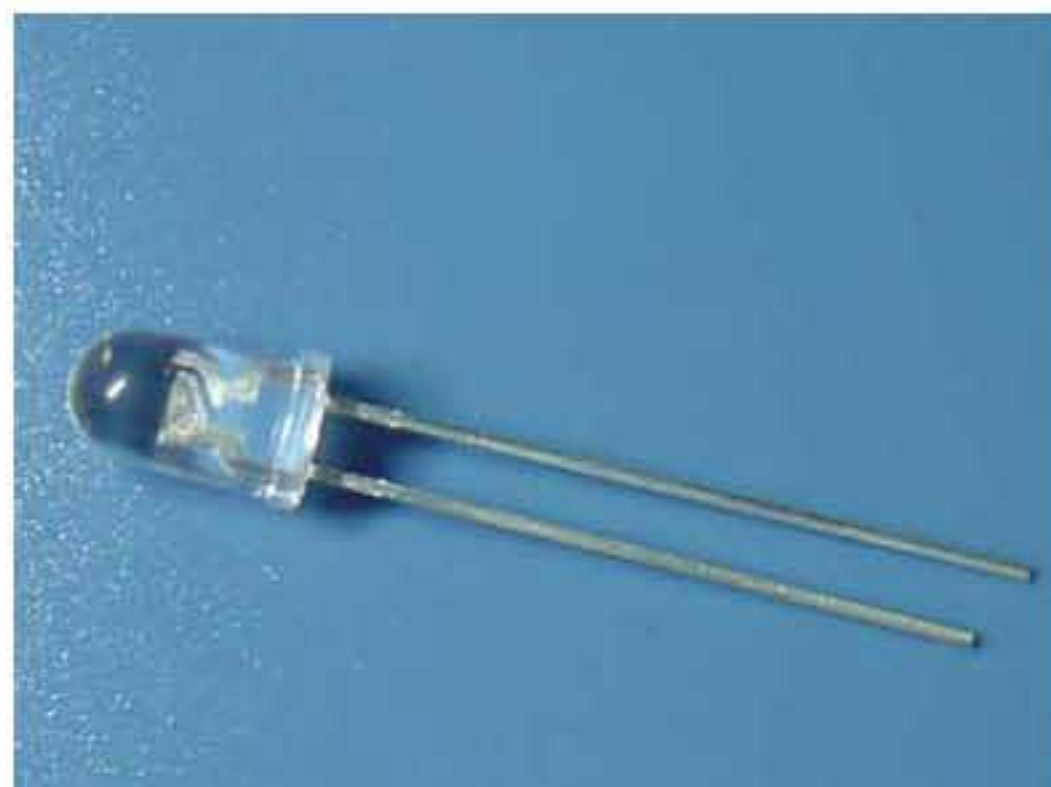

**ATTENTION**  
 OBSERVE PRECAUTIONS  
 FOR HANDLING  
 ELECTROSTATIC  
 DISCHARGE  
 SENSITIVE  
 DEVICES

508H184WC



**Features**

- $\phi 5$  LAMP LED
- LOW POWER CONSUMPTION.
- CABINED VIEWING ANGLE.
- IDEAL FOR BACKLIGHT AND INDICATOR.
- PACKAGE: 500PCS / BAG.

**Description**

This devices are made with TS InGaN.

**Package Dimensions**

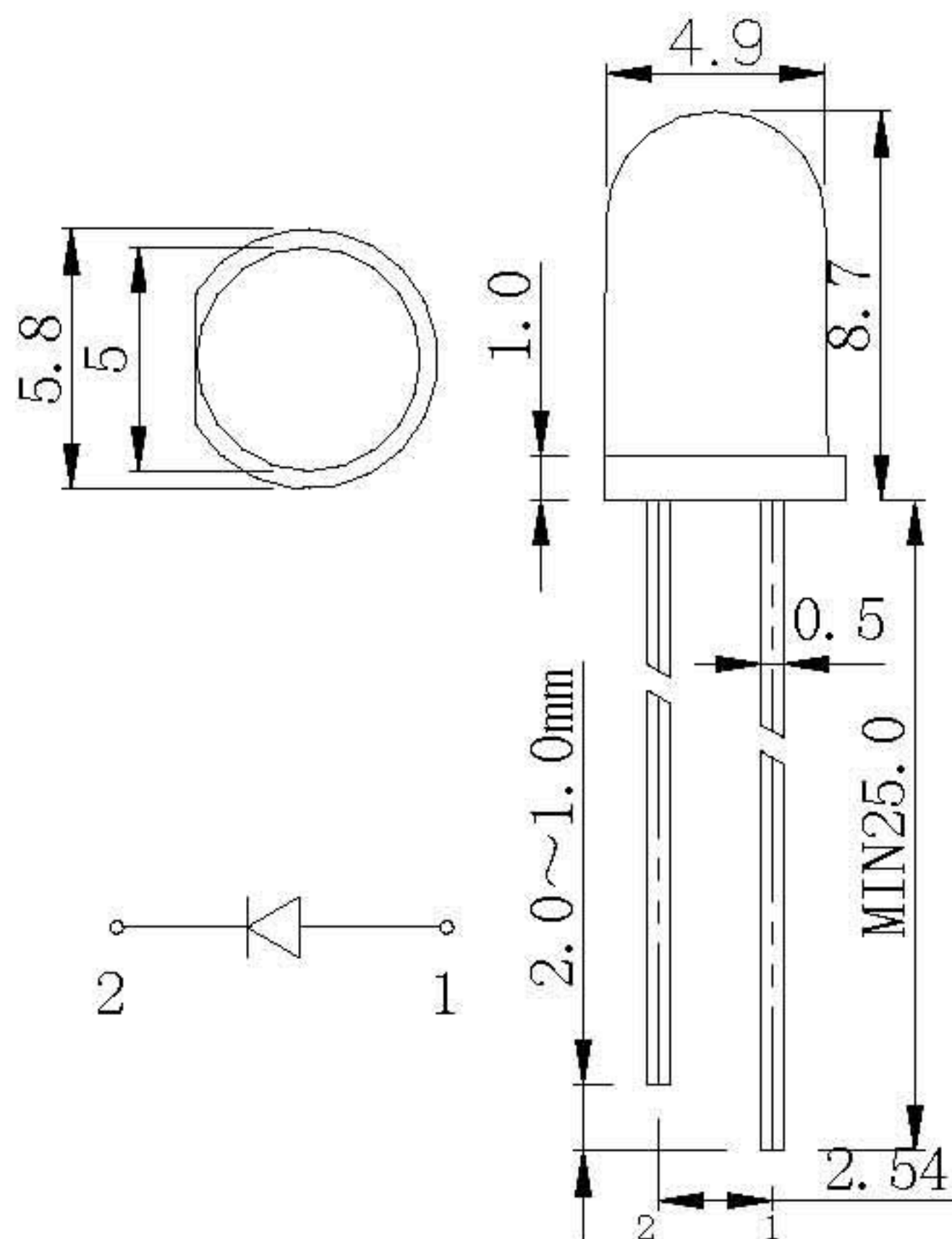

Torlerance Grade	Dimension Torlerance (UNIT:mm)			
	0.5~3	3~6	6~30	30~120
Medium(m)	$\pm 0.1$	$\pm 0.1$	$\pm 0.2$	$\pm 0.3$
Chip		Lens Color		
Material	Emitting Color	Water Clear		
InGaN	White			

### ■ Absolute Maximum Rating

Item	Symbol	Absolute Maximum Rating	Unit
Forward Current	$I_F$	20	mA
Peak Forward Current*	$I_{FP}$	100	mA
Reverse Voltage	$V_R$	5	V
Power Dissipation	$P_D$	80	mW
Electrostatic discharge	$E_{SD}$	600	V
Operation Temperature	$T_{opr}$	-25~+80	°C
Storage Temperature	$T_{stg}$	-5~+45	°C
Lead Soldering Temperature*	$T_{sol}$	Max. 260°C for 5sec Max.	

\* $I_{FP}$  Conditions: Pulse Width  $\leq 10$ msec

\* $T_{sol}$  Conditions: 3mm from the base of the epoxy bulb

### ■ Typical Optical/ Electrical Characteristics

Item	Symbol	Condition	Min.	Typ.	Max.	Unit
Forward Voltage	$V_F$	$I_F=20$ mA	2.8	3.2	3.6	V
50% Power Angle	$2\theta_{1/2}$		--	15	--	deg
Luminous Intensity	$I_V$		7000	10000	--	mcd
Chromaticity coordinates	X		--	0.29	--	X: $\pm 0.015$
	Y		--	0.30	--	Y: $\pm 0.025$
Peak Wavelength	$\lambda_D$		--	--	--	nm
Recommend Forward Current	$I_{F(rec)}$	--	--	--	20	mA
Reverse Current	$I_R$	$V_R=5$ V	--	--	10	$\mu$ A

Notes:

1. Absolute maximum ratings  $T_a=25^\circ\text{C}$ .
2. Tolerance of measurement of forward voltage  $\pm 0.1$ V.
3. Tolerance of measurement of peak Wavelength  $\pm 2.0$ nm.
4. Tolerance of measurement of luminous intensity  $\pm 15\%$ .
5. Tolerance of measurement of angle intensity  $\pm 15\%$

## ■ Reliability Performance

### Test Items And Result

Test Classification	Test Item	Test Conditions	Test Duration	Sample Size	AC/RE
Life Test	Room Temperature DC Operating Life Test	Ta=25°C±5°C, IF=20mA	1000 hrs	22 pcs	0/1
Environment Test	Thermal Shock Test	-10°C±5°C←→+100°C±5°C 5min. 10sec. 5min.	50 cycles	22 pcs	0/1
	Temperature Cycle Test	-40°C±5°C←→+85°C±5°C 30min. 5min. 30min.	50 cycles	22 pcs	0/1
	High Temperature & High Humidity Test	Ta=85°C±5°C RH =85%±0.5 %RH	1000 hrs	22 pcs	0/1
	High Temperature Storage	Ta=100°C±5°C	1000 hrs	22 pcs	0/1
	Low Temperature Storage	Ta=-55°C±5°C	1000 hrs	22 pcs	0/1
Mechanical Test	Resistance to Soldering Heat	Ta=230°C±5°C	5sec.	22 pcs	0/1
	Lead Integrity	Load 2.5N(0.25kgf) 0° ~ 90° ~0°	3times	22 pcs	0/1

Forward Current vs. Ambient Temperature

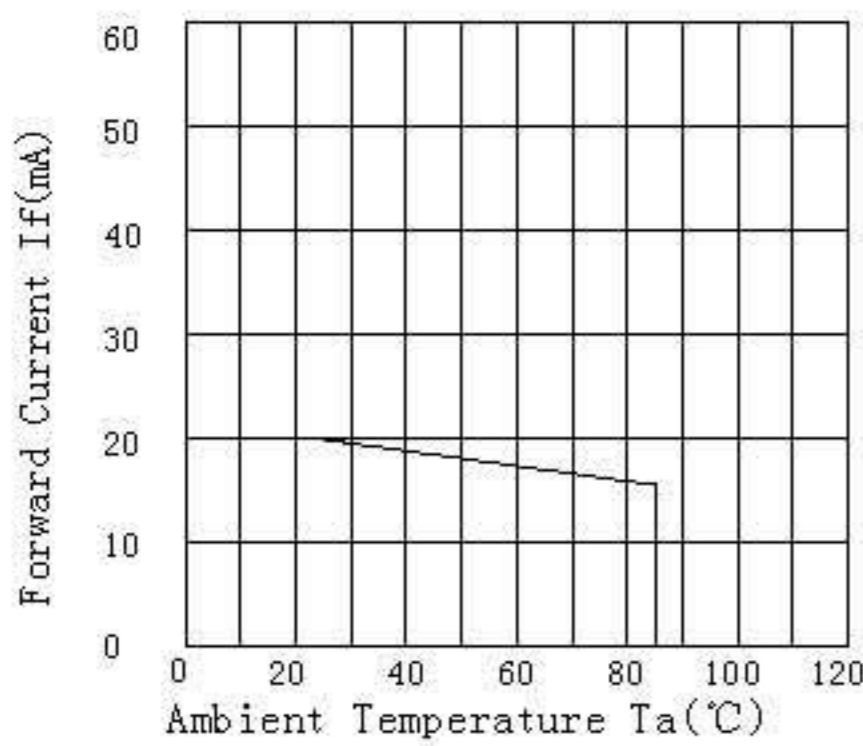

Relative Intensity IV% (mod) vs. Ambient Temperature

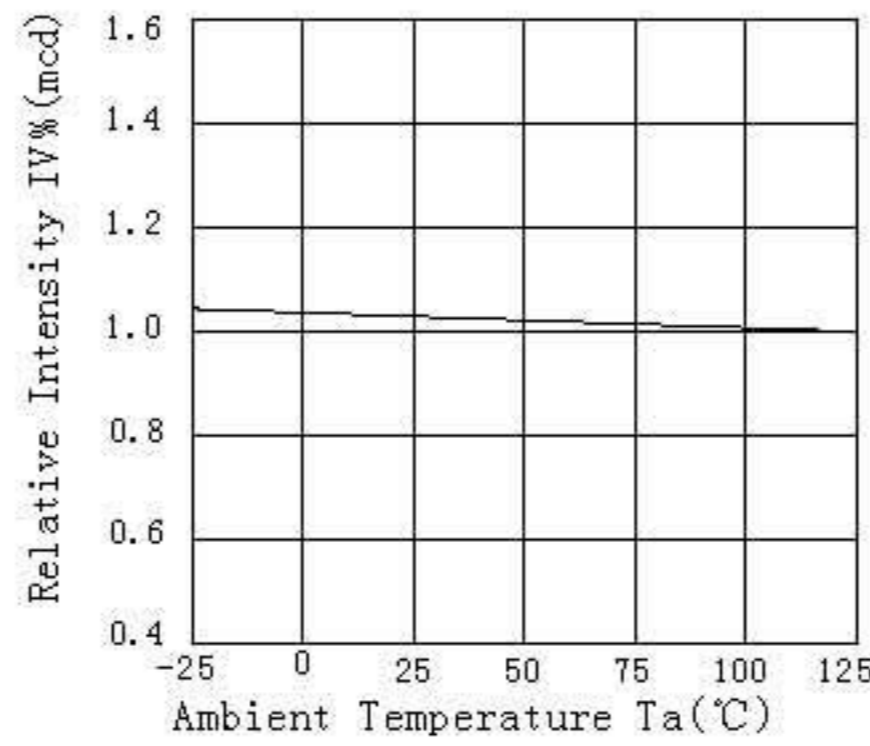

Forward Current vs. Forward Voltage

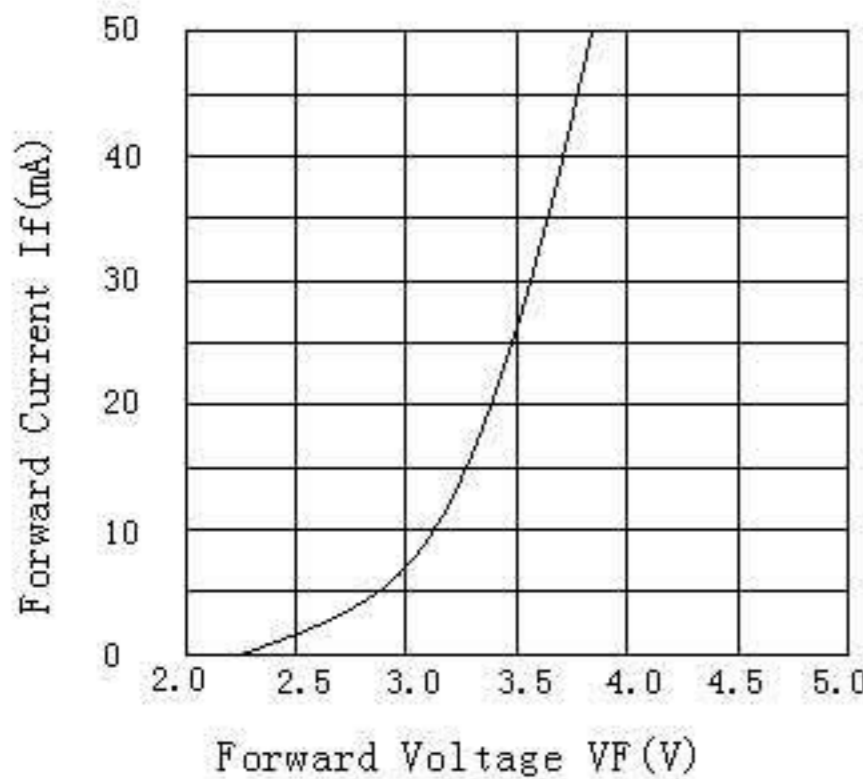

Forward Voltage vs. Ambient Temperature

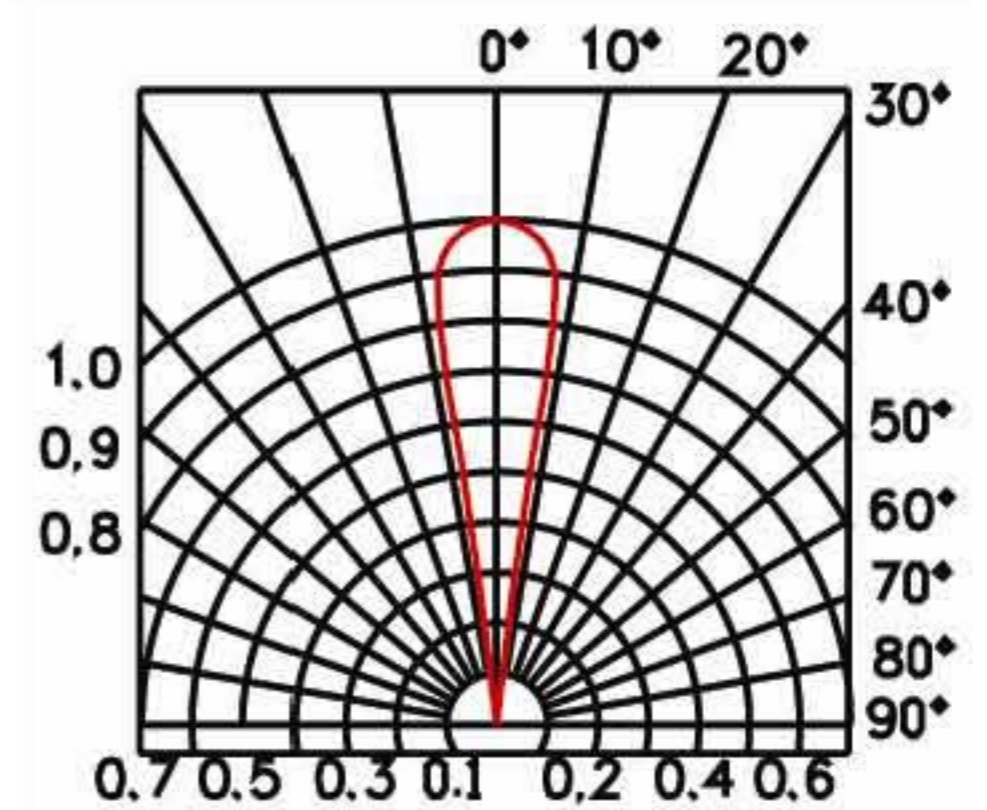
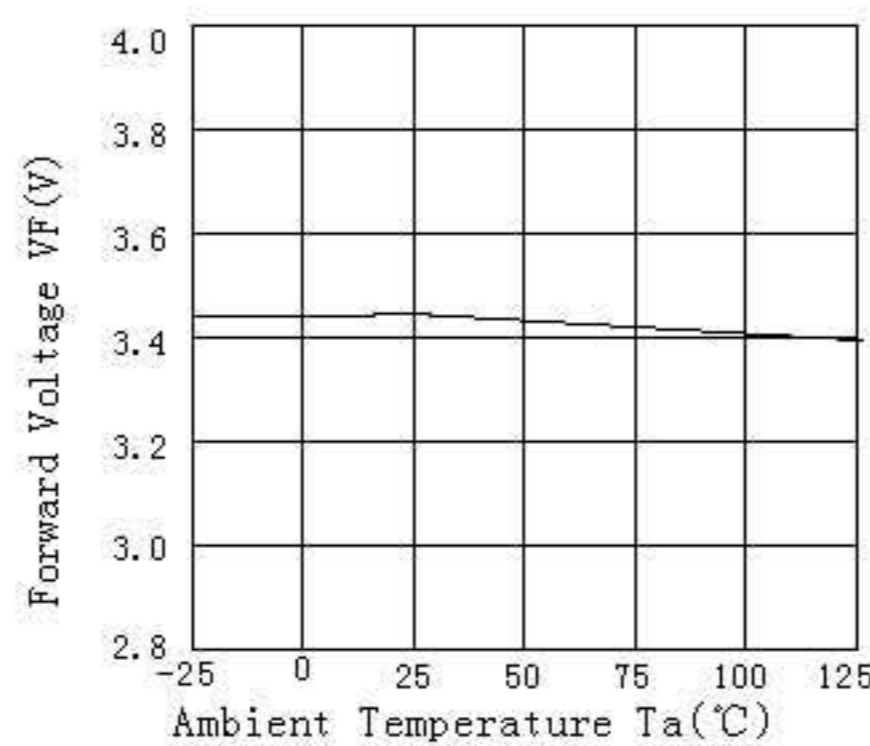

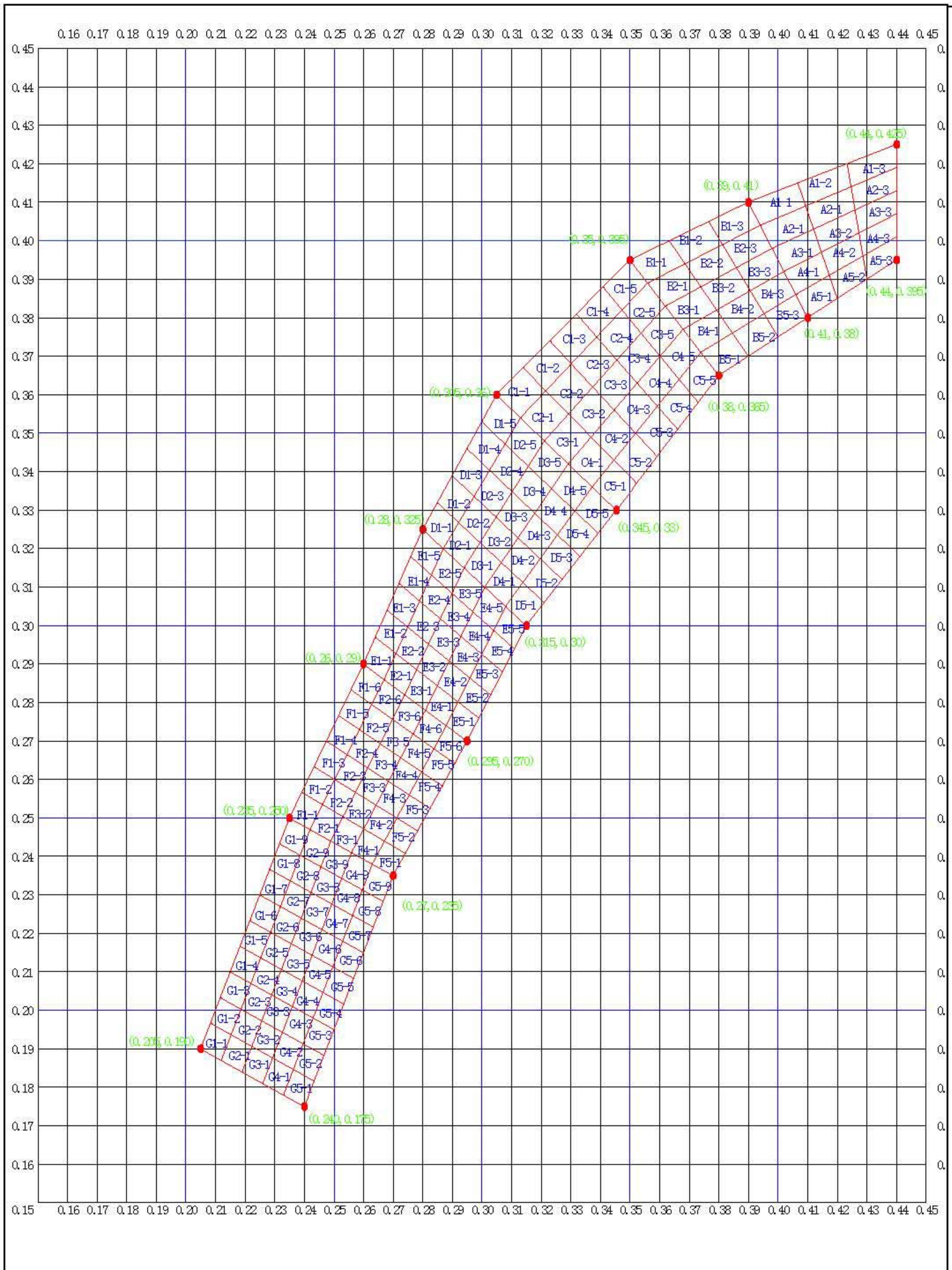

## Soldering:

### 1. Manual Of Soldering

The temperature of the iron tip should not be higher than 260°C (500°F) and Soldering within 3 seconds per solder-land is to be observed.

### 2. DIP soldering (Wave Soldering):

Preheating: 120°C~150°C, within 120~180 sec.

Operation heating: 245°C ±5°C within 5 sec. 260°C (Max)

Gradual Cooling (Avoid quenching).

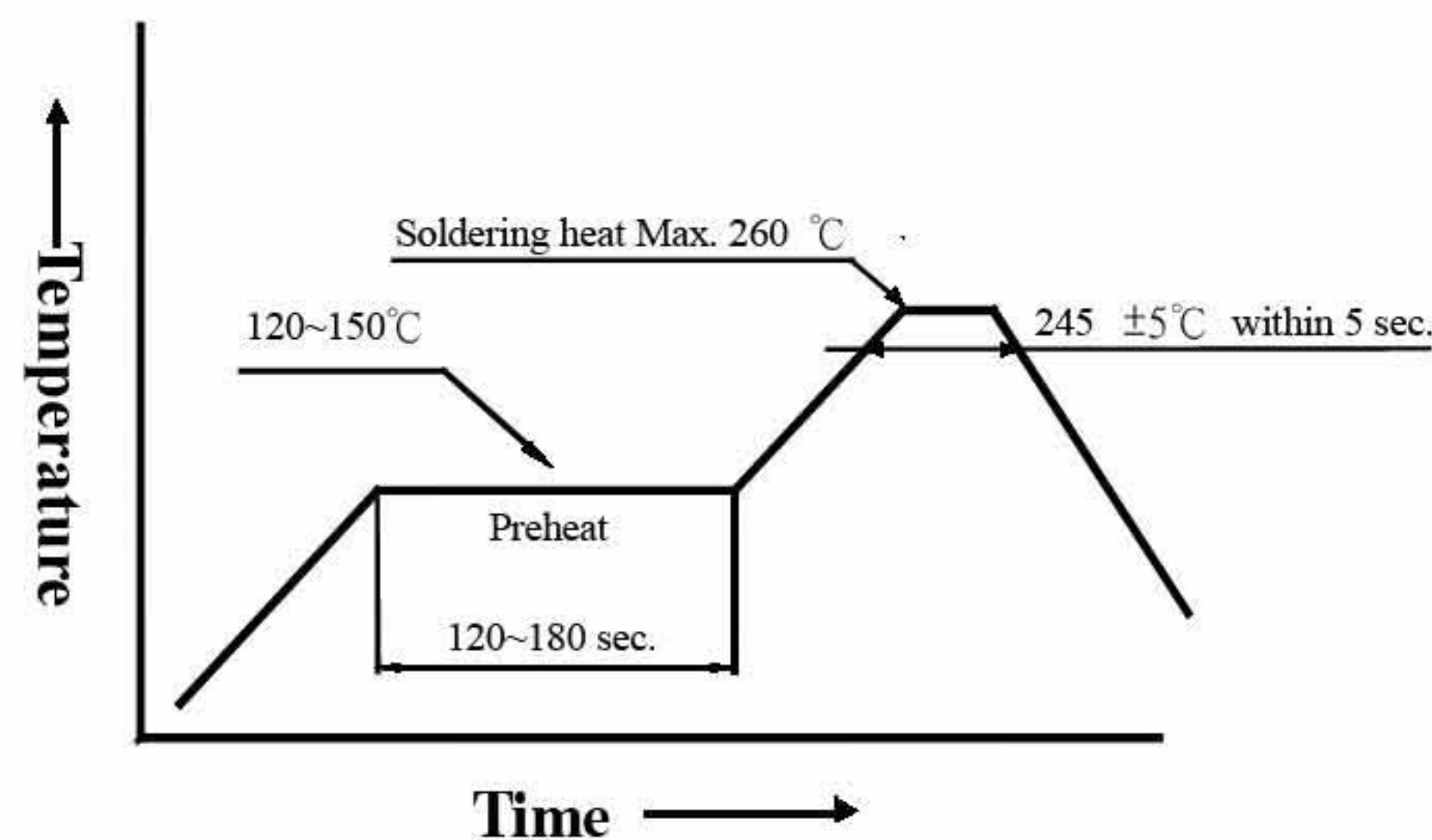

## Handling:

Care must be taken not to cause to the epoxy resin portion of LED while it is exposed to high temperature. Care must be taken not rub the epoxy resin portion of LED with hard or sharp article such as the sand blast and the metal hook.

Care must be taken there should be more than 3mm from jointing point to the epoxy resin.

## Notes for designing:

Care must be taken to provide the current limiting resistor in the circuit so as to drive the LED within the rated figures. Also caution should be taken not to overload LED with exorbitant voltage at the turning ON and OFF of the circuit.

When using the pulse drive care must be taken to keep the average current within the rated figures. Also the circuit should be designed so as to be subjected to reverse voltage when turning off the LED.

## Storage:

In order to avoid the absorption of moisture, it is recommended to solder LED as soon as possible after unpacking the sealed envelope.

If the envelope is still packed to store it in the environment as following:

Temperature: -5°C~45°C (23°F~113°F) Humidity : RH 60% Max.