

TOSHIBA POWER MOS FET MODULE SILICON N & P CHANNEL MOS TYPE (L²-π-MOSIV 4 IN 1)

MP4207

○ HIGH POWER HIGH SPEED SWITCHING APPLICATIONS.

○ H - SWITCH DRIVER

• 4-Volt Gate Drive.

• Small Package by Full Molding. (SIP 10 Pin)

• High Drain Power Dissipation. (4 Devices Operation)

$$: P_T = 4W @ T_a = 25^\circ C$$

• Low Drain-Source ON Resistance

$$: R_{DS(ON)} = 90m\Omega \text{ TYP. (Nch)}$$

$$: R_{DS(ON)} = 170m\Omega \text{ TYP. (Pch)}$$

• Low Leakage Current : $I_{GSS} = \pm 10\mu A$ (Max.) @ $V_{GS} = \pm 16V$

$$: I_{DSS} = 100\mu A$$
 (Max.) @ $V_{DS} = 60V$

• Enhancement-Mode : $V_{th} = 0.8 \sim 2.0V$ @ $I_D = 1mA$

INDUSTRIAL APPLICATIONS

Unit in mm

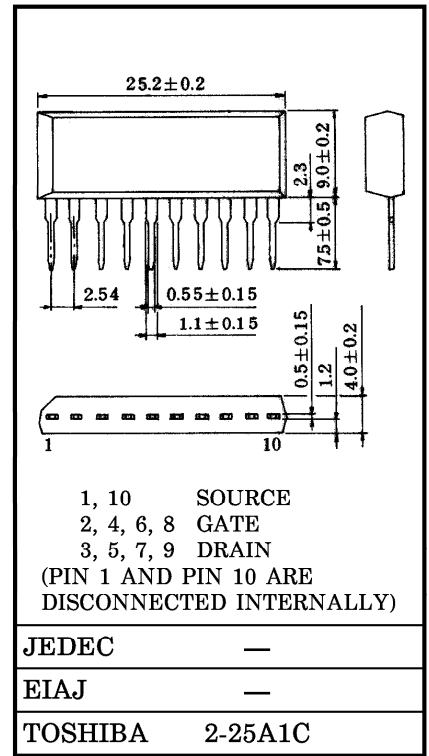

MAXIMUM RATINGS (Ta = 25°C)

CHARACTERISTIC	SYMBOL	RATING		UNIT
		Nch	Pch	
Drain-Source Voltage	V_{DSS}	60	-60	V
Gate-Source Voltage	V_{GSS}	±20	±20	V
Drain Current	I_D	5	-5	A
Peak Drain Current	I_{DP}	10	-10	A
Drain Power Dissipation (1 Device Operation, Ta = 25°C)	P_D	2.0		W
Drain Power Dissipation (4 Devices Operation, Ta = 25°C)	P_T	4.0		W
Channel Temperature	T_{ch}	150		°C
Storage Temperature Range	T_{stg}	-55~150		°C

ARRAY CONFIGURATION

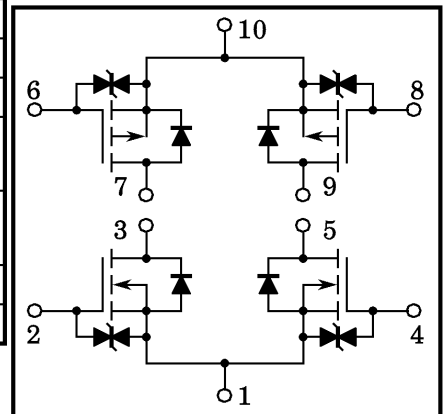

THERMAL CHARACTERISTICS

CHARACTERISTIC	SYMBOL	RATING	UNIT
Thermal Resistance of Channel to Ambient (4 Devices Operation, Ta = 25°C)	$\Sigma R_{th(ch-a)}$	31.2	°C / W
Maximum Lead Temperature for Soldering Purposes (3.2mm from Case for 10 second)	T_L	260	°C

THIS TRANSISTOR IS AN ELECTROSTATIC SENSITIVE DEVICE. PLEASE HANDLE WITH CAUTION.

ELECTRICAL CHARACTERISTICS (Ta = 25°C) (Nch MOS FET)

CHARACTERISTIC		SYMBOL	TEST CONDITION	MIN.	TYP.	MAX.	UNIT
Gate Leakage Current		I_{GSS}	$V_{GS} = \pm 16V, V_{DS} = 0$	—	—	± 10	μA
Drain Cut-off Current		I_{DSS}	$V_{DS} = 60V, V_{GS} = 0$	—	—	100	μA
Drain-Source Breakdown Voltage		$V_{(BR)DSS}$	$I_D = 10mA, V_{GS} = 0$	60	—	—	V
Gate Threshold Voltage		V_{th}	$V_{DS} = 10V, I_D = 1mA$	0.8	—	2.0	V
Forward Transfer Admittance		$ Y_{fs} $	$V_{DS} = 10V, I_D = 2.5A$	3.0	6.0	—	S
Drain-Source ON Resistance		$R_{DS(ON)}$	$I_D = 2.5A, V_{GS} = 4V$	—	135	200	$m\Omega$
Drain-Source ON Resistance		$R_{DS(ON)}$	$I_D = 2.5A, V_{GS} = 10V$	—	90	130	$m\Omega$
Input Capacitance		C_{iss}	$V_{DS} = 10V, V_{GS} = 0, f = 1MHz$	—	500	900	pF
Reverse Transfer Capacitance		C_{rss}		—	90	180	pF
Output Capacitance		C_{oss}		—	290	500	pF
Switching Time	Rise Time	t_r	<p>$V_{IN} : t_r, t_f < 5ns$ $Du. \leq 1\% (Z_{OUT} = 50\Omega)$</p>	—	20	40	ns
	Turn-on Time	t_{on}		—	60	120	
	Fall Time	t_f		—	80	160	
	Turn-off Time	t_{off}		—	300	600	
Total Gate Charge (Gate-Source Plus Gate-Drain)		Q_g	$I_D = 5A, V_{GS} = 10V$ $V_{DD} = 48V$	—	20	40	nC
Gate-Source Charge		Q_{gs}		—	14	—	nC
Gate-Drain ("Miller") Charge		Q_{gd}		—	6	—	nC

SOURCE-DRAIN DIODE RATING AND CHARACTERISTICS (Ta = 25°C)

CHARACTERISTIC	SYMBOL	TEST CONDITION	MIN.	TYPE	MAX.	UNIT
Drain Reverse Current	I_{DR}	—	—	—	5	A
Peak Drain Reverse Current	I_{DRP}	—	—	—	10	A
Diode Forward Voltage	V_{DSF}	$I_{DR} = 5A, V_{GS} = 0$	—	—	-1.5	V
Reverse Recovery Time	t_{rr}	$I_{DR} = 5A, V_{GS} = 0$	—	140	—	ns
Reverse Recovery Charge	Q_{rr}	$dI_{DR} / dt = -50A / \mu s$	—	0.4	—	μC

ELECTRICAL CHARACTERISTICS (Ta = 25°C) (Pch MOS FET)

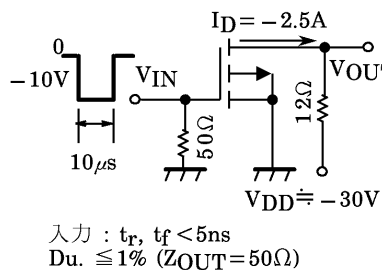
CHARACTERISTIC		SYMBOL	TEST CONDITION	MIN.	TYP.	MAX.	UNIT
Gate Leakage Current		I_{GSS}	$V_{GS} = \pm 16V, V_{DS} = 0$	—	—	± 10	μA
Drain Cut-off Current		I_{DSS}	$V_{DS} = -60V, V_{GS} = 0$	—	—	-100	μA
Drain-Source Breakdown Voltage		$V_{(BR)DSS}$	$I_D = -10mA, V_{GS} = 0$	-60	—	—	V
Gate Threshold Voltage		V_{th}	$V_{DS} = -10V, I_D = -1mA$	-0.8	—	-2.0	V
Forward Transfer Admittance		$ Y_{fs} $	$V_{DS} = -10V, I_D = -2.5A$	1.0	2.0	—	S
Drain-Source ON Resistance		$R_{DS(ON)}$	$I_D = -2.5A, V_{GS} = -4V$	—	250	400	$m\Omega$
Drain-Source ON Resistance		$R_{DS(ON)}$	$I_D = -2.5A, V_{GS} = -10V$	—	170	250	$m\Omega$
Input Capacitance		C_{iss}	$V_{DS} = -10V, V_{GS} = 0, f = 1MHz$	—	500	720	pF
Reverse Transfer Capacitance		C_{rss}		—	90	150	pF
Output Capacitance		C_{oss}		—	290	420	pF
Switching Time	Rise Time	t_r	 <p>入力 : $t_r, t_f < 5ns$ $D_u \leq 1\%$ ($Z_{OUT} = 50\Omega$)</p>	—	120	240	ns
	Turn-on Time	t_{on}		—	130	260	
	Fall Time	t_f		—	80	160	
	Turn-off Time	t_{off}		—	200	400	
Total Gate Charge (Gate-Source Plus Gate-Drain)		Q_g	$I_D = -5A, V_{GS} = -10V$ $V_{DD} = -48V$	—	22	45	nC
Gate-Source Charge		Q_{gs}		—	14	—	nC
Gate-Drain ("Miller") Charge		Q_{gd}		—	8	—	nC

SOURCE-DRAIN DIODE RATINGS AND CHARACTERISTICS (Ta = 25°C)

CHARACTERISTIC	SYMBOL	TEST CONDITION	MIN.	TYPE	MAX.	UNIT
Drain Reverse Current	I_{DR}	—	—	—	-5	A
Peak Drain Reverse Current	I_{DRP}	—	—	—	-10	A
Diode Forward Voltage	V_{DSF}	$I_{DR} = -5A, V_{GS} = 0$	—	—	1.5	V
Reverse Recovery Time	t_{rr}	$I_{DR} = -5A, V_{GS} = 0$	—	120	—	ns
Reverse Recovery Charge	Q_{rr}	$dI_{DR} / dt = -50A / \mu s$	—	0.24	—	μC

Nch FET

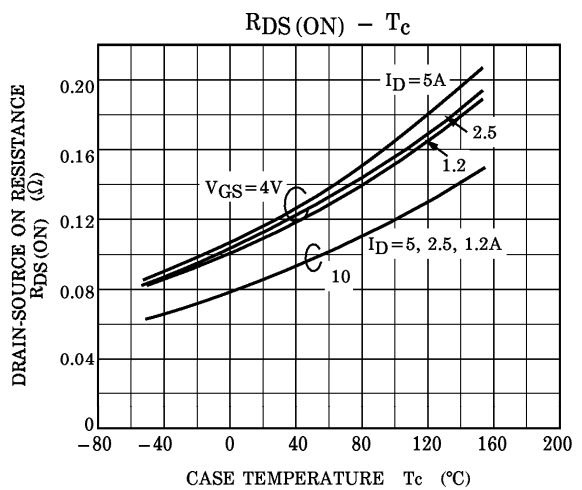
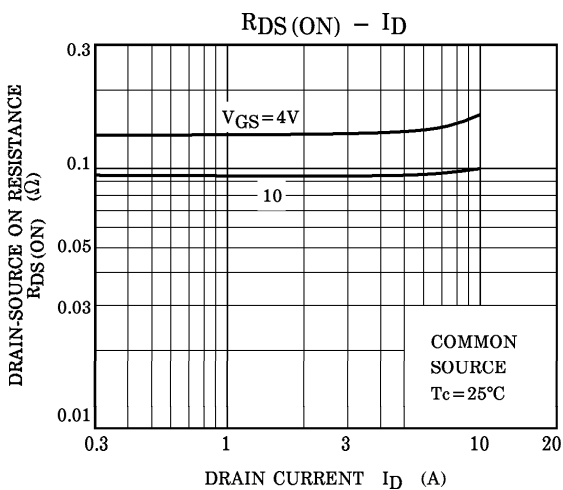
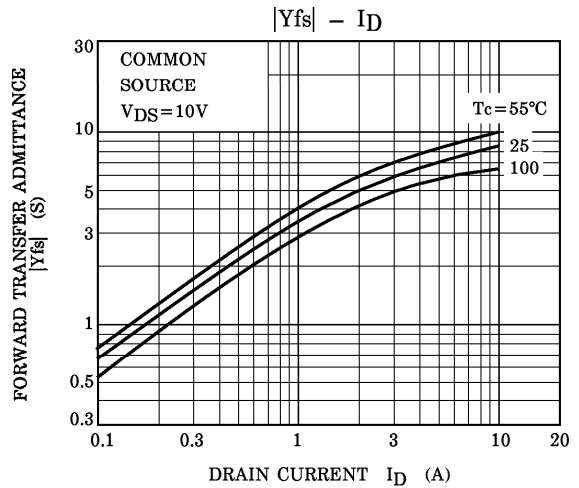
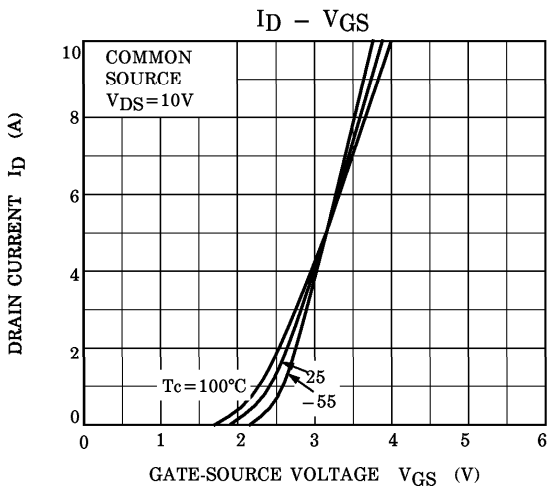
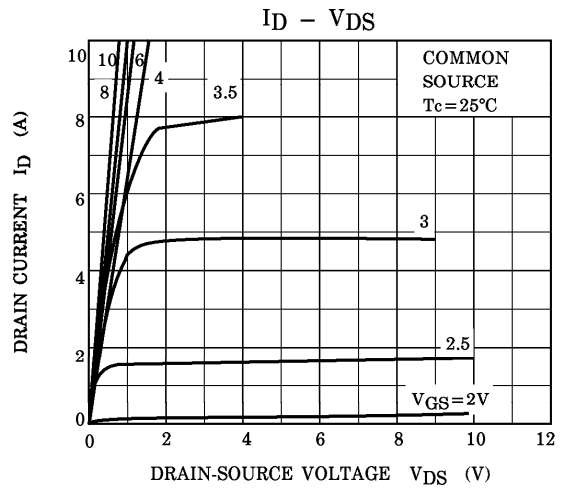
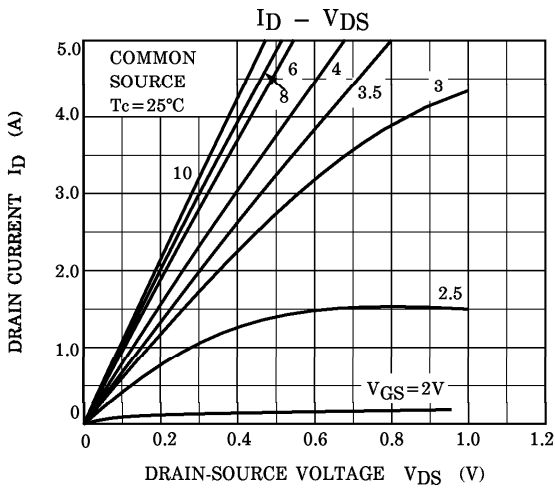

Nch FET

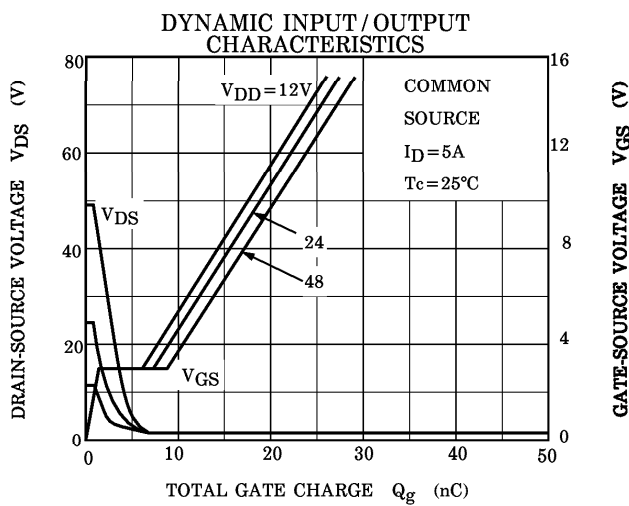
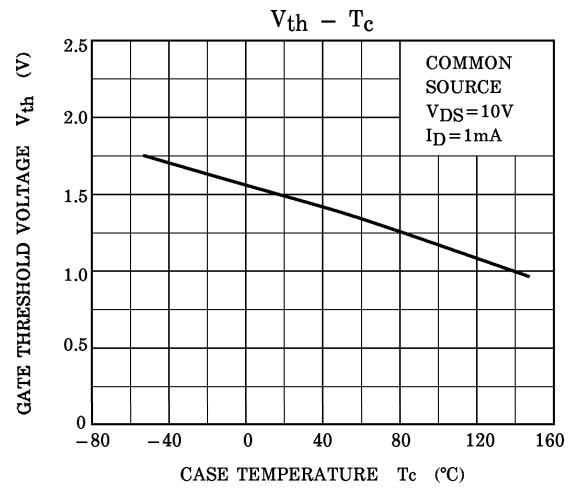
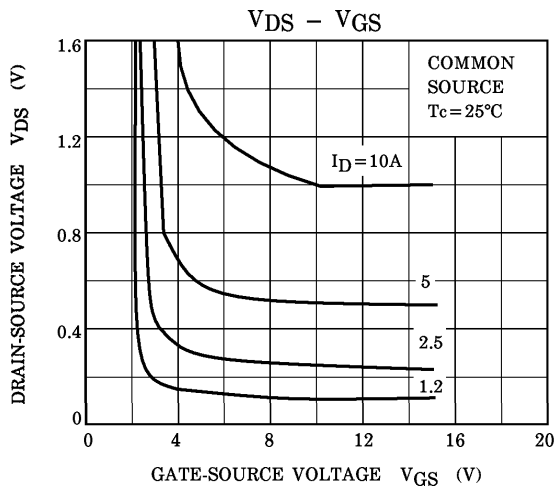
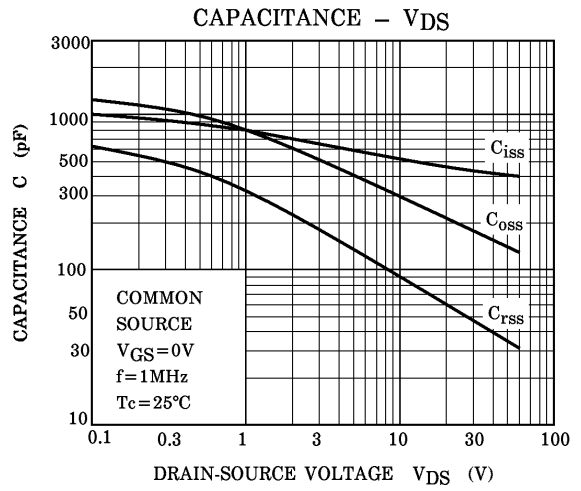
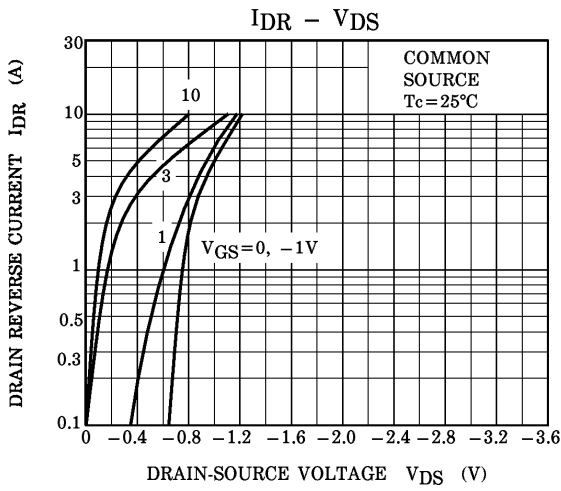

Pch FET

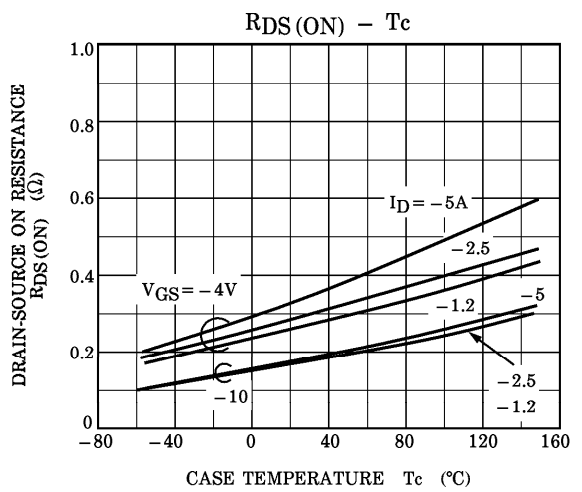
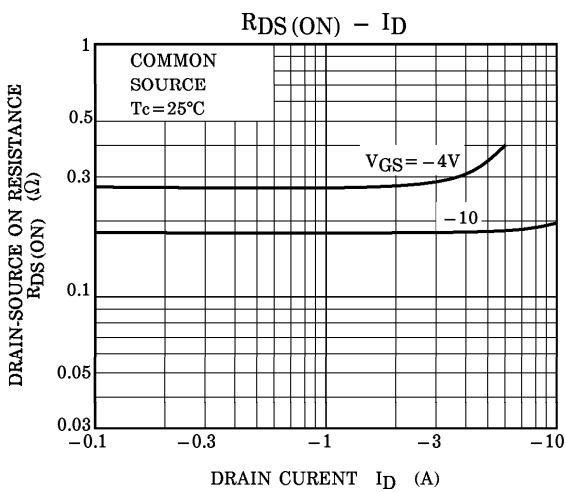
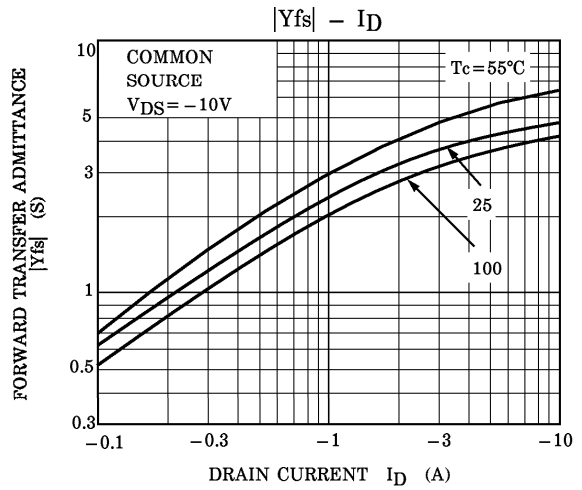
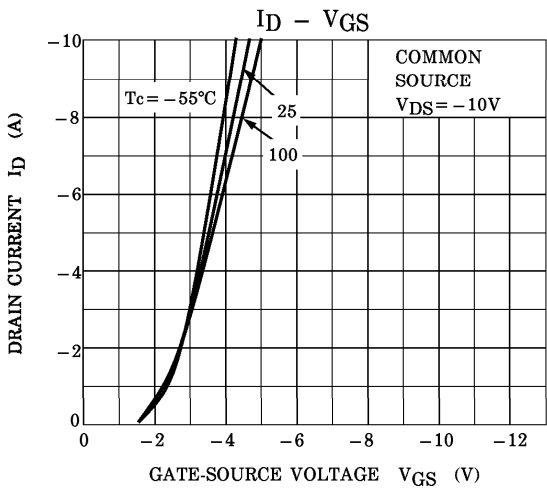
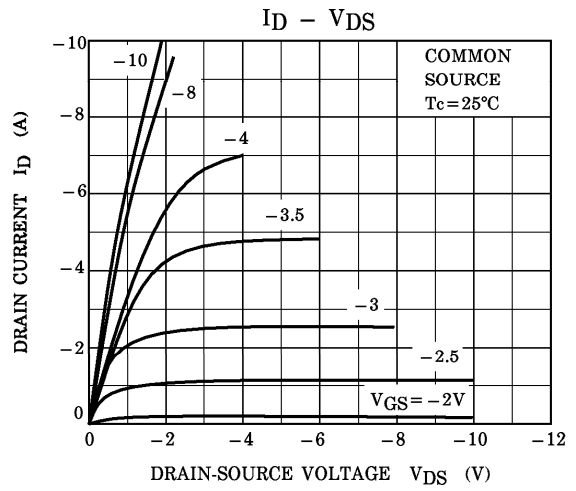
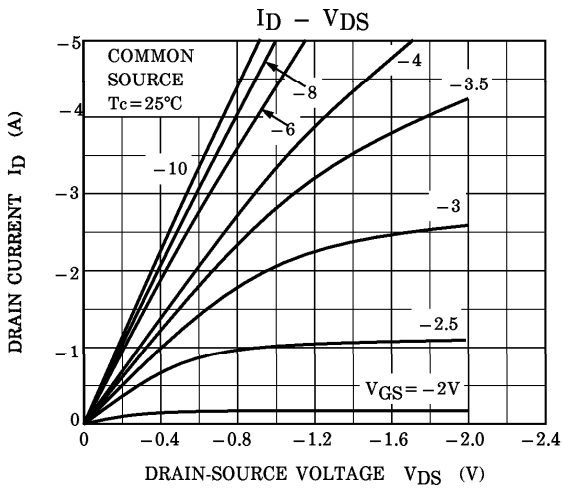

Pch FET

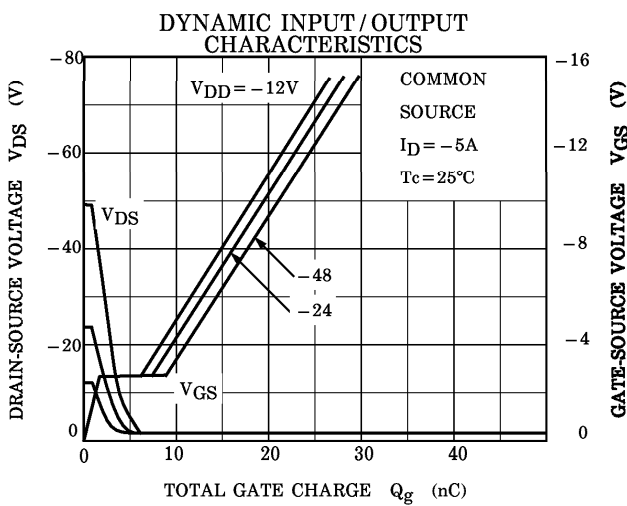
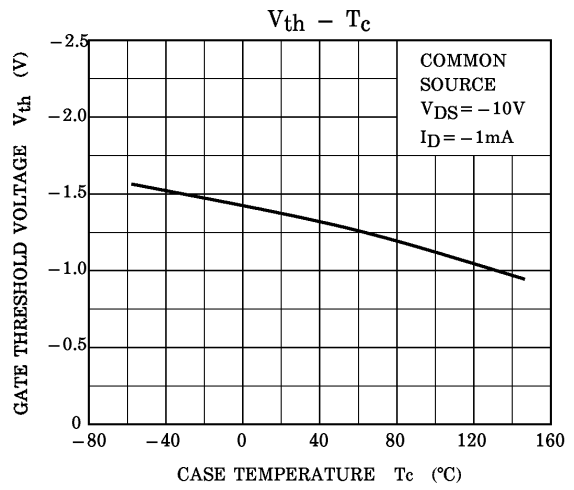
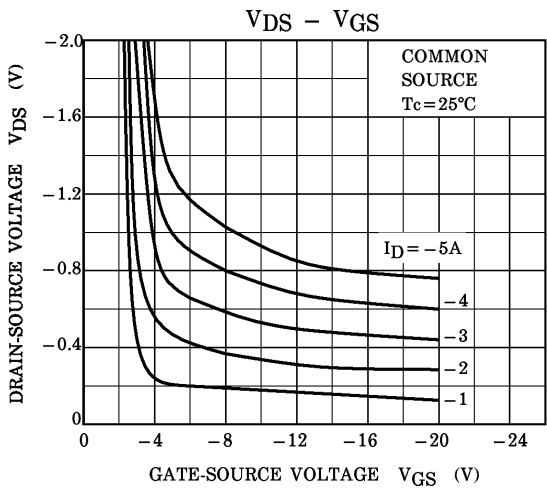
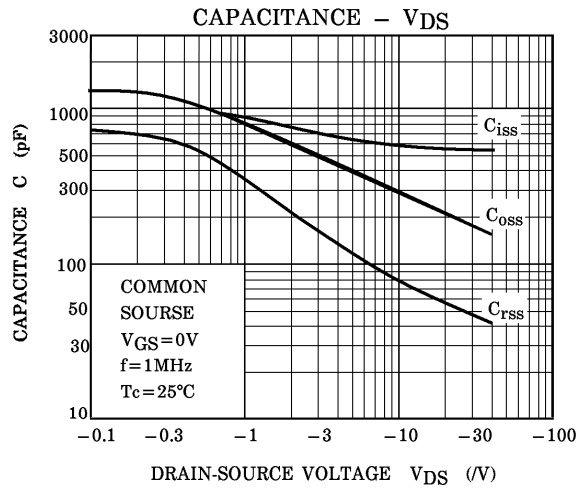
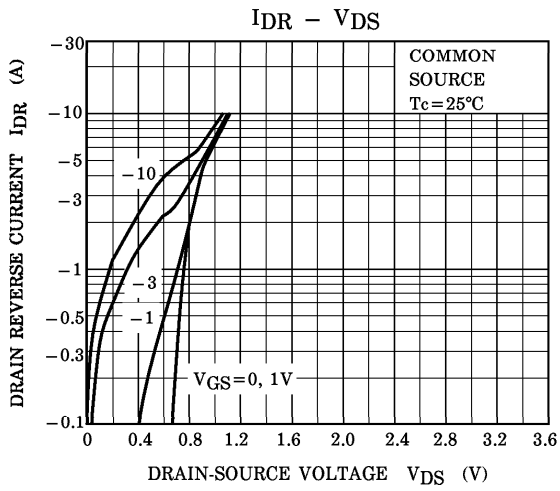

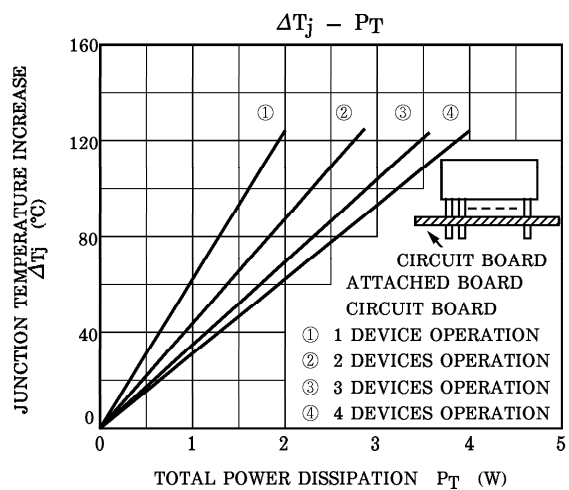
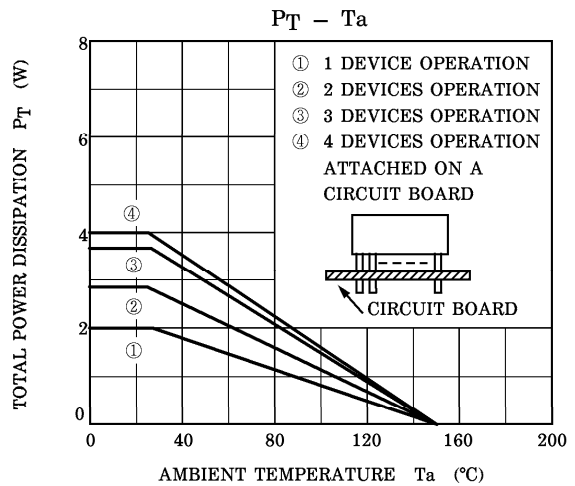
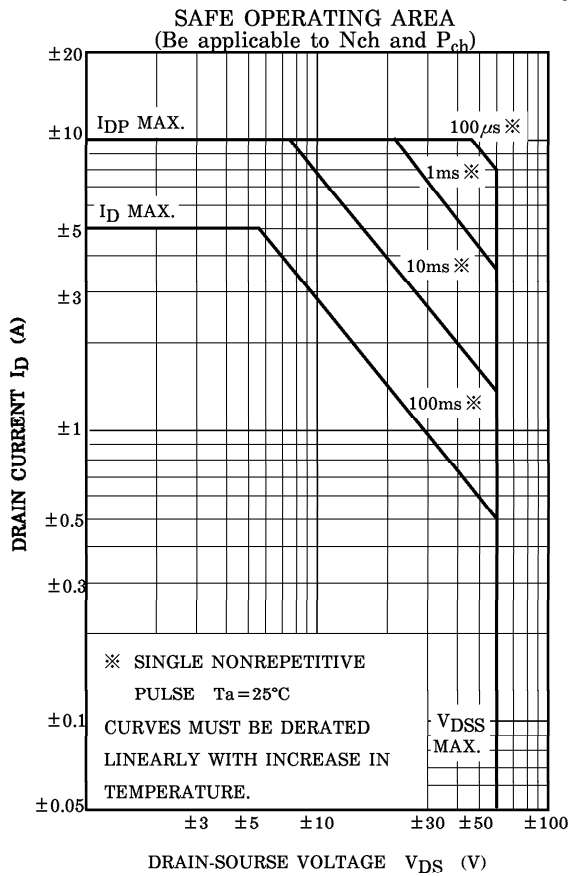
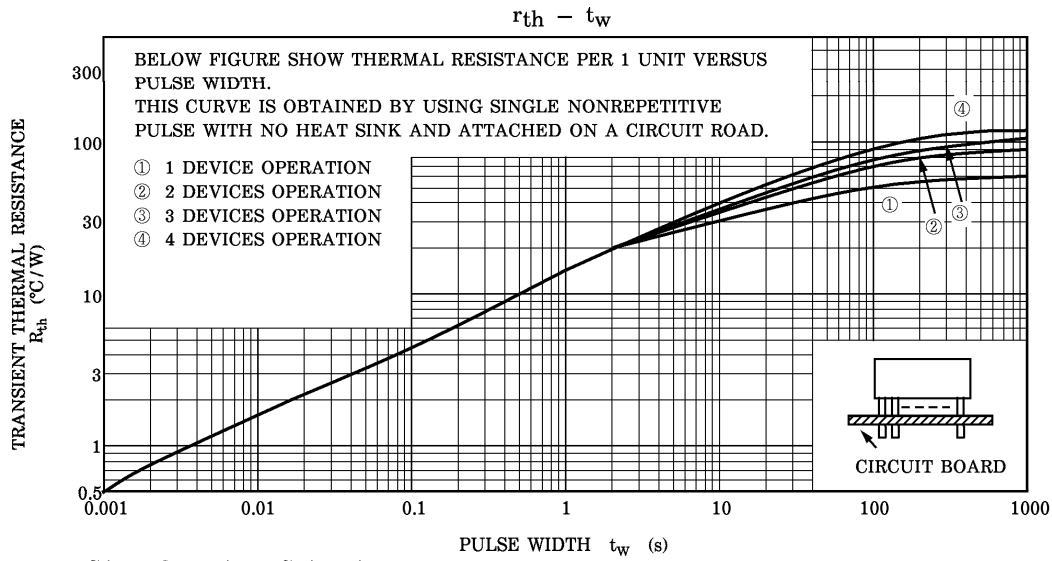

RESTRICTIONS ON PRODUCT USE

000707EAA

- TOSHIBA is continually working to improve the quality and reliability of its products. Nevertheless, semiconductor devices in general can malfunction or fail due to their inherent electrical sensitivity and vulnerability to physical stress. It is the responsibility of the buyer, when utilizing TOSHIBA products, to comply with the standards of safety in making a safe design for the entire system, and to avoid situations in which a malfunction or failure of such TOSHIBA products could cause loss of human life, bodily injury or damage to property. In developing your designs, please ensure that TOSHIBA products are used within specified operating ranges as set forth in the most recent TOSHIBA products specifications. Also, please keep in mind the precautions and conditions set forth in the "Handling Guide for Semiconductor Devices," or "TOSHIBA Semiconductor Reliability Handbook" etc..
- The TOSHIBA products listed in this document are intended for usage in general electronics applications (computer, personal equipment, office equipment, measuring equipment, industrial robotics, domestic appliances, etc.). These TOSHIBA products are neither intended nor warranted for usage in equipment that requires extraordinarily high quality and/or reliability or a malfunction or failure of which may cause loss of human life or bodily injury ("Unintended Usage"). Unintended Usage include atomic energy control instruments, airplane or spaceship instruments, transportation instruments, traffic signal instruments, combustion control instruments, medical instruments, all types of safety devices, etc.. Unintended Usage of TOSHIBA products listed in this document shall be made at the customer's own risk.
- The information contained herein is presented only as a guide for the applications of our products. No responsibility is assumed by TOSHIBA CORPORATION for any infringements of intellectual property or other rights of the third parties which may result from its use. No license is granted by implication or otherwise under any intellectual property or other rights of TOSHIBA CORPORATION or others.
- The information contained herein is subject to change without notice.